

—UPGRADE—AND—  
—RETROFIT—  
—ROTOFORM—  
—CONVENTIONAL—

# —UPGRADE YOUR ROTOFORM CONVENTIONAL SYSTEM

The IPCO Rotoform is the most successful system of its kind on the market. Introduced in the early 1980s, it has gone on to be trusted by processors the world over, with more than 2,000 lines installed to date.

Our earliest model, the Rotoform Conventional, was superseded by the RF3000 system in 1995 and a process of on-going improvement has seen additional performance enhancements and the arrival of more advanced technology offering improved safety and easier operation/maintenance.

Our spare parts support for the RF Conventional system ceased at the end of 2020, but we now offer a retrofit upgrade package that enables end users to continue to benefit from our support, and to do so for many years to come..





We continued to support the Rotoform Conventional throughout this 25 year period – far longer than the 10 years considered standard practice by most machine builders.

Hinged refeed bar for easy maintenance and cleaning



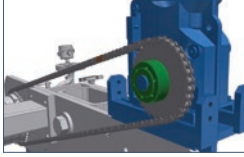
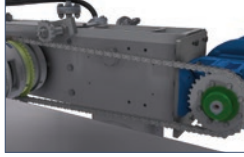



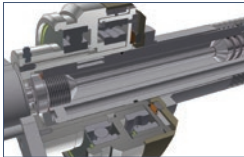
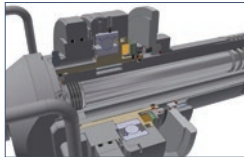

# Rotoform 4G retrofit package - the benefits

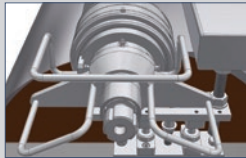
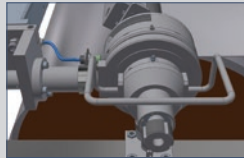
This upgrade package to our latest Rotoform 4G model offers a number of important benefits:

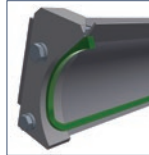
	Rotoform Conventional	Rotoform 4G
<b>Drive chain</b>		
<b>Gear motor adaption</b>	Offset installation. Requires on-going adjustment.	Fixed horizontal installation. Once-only installation and setting. No further adjustment necessary.
<b>Speed control</b>	Manually controlled gear drive.	Fully automated – frequency controlled.
<b>Drive chain</b>	No chain tensioner – tightening requires drive to be adjusted. Requires on-going adjustment.	Chain tensioner included – no safety clutch needed. Less chain vibration, less wear and tear, less maintenance.
<b>Chain tensioner</b>	No chain tensioner.	Chain tensioning device enables easy tensioning. Extended chain life, reduced maintenance/time. Better access
<b>Stator</b>	 	 
<b>Pre-distribution nozzle – low viscosity</b>	Offset nozzle increases wear and tear the seal resulting in reduced product quality. Also reduces metering bar performance Special exchange tool required.	Central nozzle with improved design. Improved product quality due to enhanced sealing and metering bar performance. Lower maintenance costs, longer seal life. Improved accessibility. Standard tools for exchange.
<b>Bearing units</b>		
<b>Mechanical seals</b>	Seal installed between shell and bearing unit. Tensioning requires system to be fully assembled. Complex installation, high wear and tear. Sealing ring installed at outer shell (shrinking connection). Counter ring installed in bearing housing.	Complete mechanical seals installed in bearing units. Fixed pre-tension. Long-lasting hard metal material, easy to maintain/replace. Available in food grade. Performance of the counter ring sealing can be seen from outside. Drive side bearing unit can be maintained without removal from stator.
<b>Ball bearings</b>	Can be flooded by product easily.	Positioned out of reach of product Less wear and tear, increased working life.

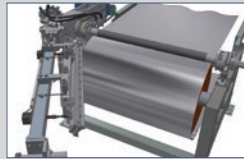
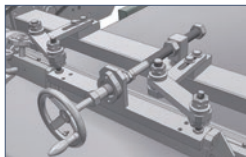
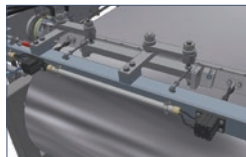

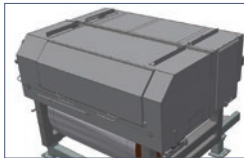
	<b>Rotoform Conventional</b>	<b>Rotoform 4G</b>
<b>Refeed bar</b>		
Refeed bar	 <p>Refeed bar support is not connected to stator.</p>	 <p>Refeed bar and stator are connected during operation. Once-only basic adjustment during assembly. No re-adjustment required after gap adjustment.</p>
Sealing	 <p>Three-piece design.</p>	 <p>Complete one-piece design. Better sealing performance, better product quality.</p>
Maintenance	 <p>Complicated due to limited access.</p>	 <p>Readily accessible for safe, easy maintenance/cleaning. No further adjustment after refeed bar sealing replacement.</p>
Refeed bar actuation	 <p>Mechanical. Single point (central).</p>	 <p>Mechanical or pneumatic options – automatization possible. Double point (off center). Homogeneous sealing performance.</p>
<b>Safety hood</b>		
Safety hood	 <p>No CE approval.</p>	 <p>Meets latest CE safety standard Safety – hood is locked during operation. Optional illumination.</p>

## Upgrade and retrofit – the key benefits

We no longer supply spare parts for our original Rotoform Conventional system. We are therefore offering a seamless upgrade package, one that not only enables continuing support of these game-changing systems but also brings with it a range of significant performance enhancements.

- Improved safety hood – fully encloses all hot and moving parts.
- Simplified operation.
- Service friendly bearing assemblies require less maintenance.
- Hinged refeed bar for easier replacement of wiper material.

By upgrading your system, you will be taking advantage of the latest Rotoform technology while at the same time protecting your investment.

To find out more, talk to your usual IPCO contact.

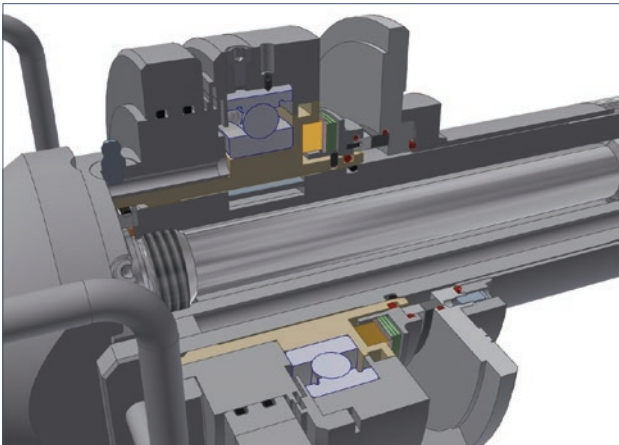



**—UPGRADE—AND—  
—RETROFIT—  
—ROTOFORM—  
—CONVENTIONAL—**